

# Nano\_Link

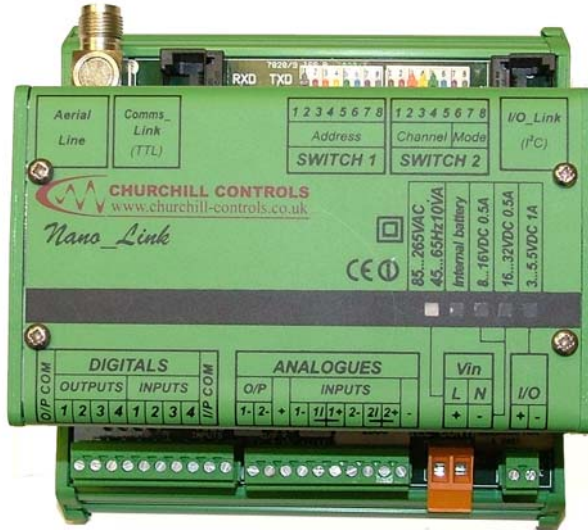

## Quick-Start Manual

V1.9 February 2009

Churchill Controls Ltd  
Unit 2 Station Industrial Estate  
Wokingham  
Berkshire, RG41 2YQ  
Tel: +44(0)118 989 2200  
Fax: +44(0)118 989 2007

 **CHURCHILL CONTROLS**  
[www.churchill-controls.co.uk](http://www.churchill-controls.co.uk)

# Introduction

## Nano Link

A *Nano\_Link* is a telemetry module, which operates as part of a larger telemetry system. It can be an outstation or a basestation and can communicate with another *Nano\_Link*, or a Churchill Controls *Micro\_Link* module.

It communicates either over low-power radio, over a leased-line or over a private-wire connection.

It has:

- 4 Digital Inputs each of which may be used as a pulse count input
- 2 Analogue Inputs
- 2 Analogue Outputs
- Mains or Battery power supply
- Switched 10V Output for Transducer Supply

All setting up is from DIP switches on the *Nano\_Link* Unit.

For full installation instructions, you must refer to the Technical Manuals supplied with the equipment.

### **IMPORTANT NOTE FOR USERS INSTALLING LEASED LINE EQUIPMENT**

Products equipped with integral leased line modems comply with the TTE directive 91/263/EEC and this user installation manual forms part of the equipment approval and as such must be read before installation work is carried out.

Failure to install the equipment in accordance with this guide will invalidate the approval. The approval will also be invalidated if the equipment is subject to modification in any way.

### **IMPORTANT NOTE FOR USERS INSTALLING RADIO EQUIPMENT.**

Products equipped with integral radio transceivers are approved to MPT1329 and ETS 300 220-1 and are therefore permitted to be used anywhere within the UK without the need for a licence. They have been setup in accordance with application information supplied to us. The radio power has been set according to the antennas that have been specified for use on particular sites, Use of different antennas may result in the effective radiated power (ERP) exceeding 500mW and thus violation of the approval regulations. The output power should not be adjusted without the use of a power meter and due attention must be made to the calculation of ERP for the installed antenna. For assistance in this matter please contact Churchill Controls.

# Power Supply

Nano\_Link has six power supply options. These are denoted by a red or white flag in the relevant window on the front of the unit as shown:

**Mains:**

The internal power pack accepts an input in the range 80..260VAC. It includes rechargeable Ni-Cad batteries to support the unit in the event of a mains failure.

**Internal Battery:**

The internal battery pack holds three D alkaline cells. Care should be taken to configure the unit to with settings which optimise battery life.

**12V Supply:**

The unit will operate from a supply in the range 8...16VDC. This is intended for operation from 12V nominally.

**24V Supply:**

The unit will operate from a supply in the range 16...32VDC. This is intended for operation from 24V nominally.

**5V Supply:**

The unit will operate from a supply in the range 3...5.5VDC. This is intended for operation from 5V nominally.

**Solar Supply:**

Solar power requires a solar panel, solar controller and lead-acid battery. Refer to the Installation Manual for details.

## Communications

Nano\_Link can communicate via low-power radio, leased-line or private wire. The installation requirements for each are detailed below:

### **Radio:**

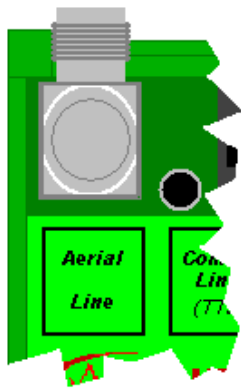

If the unit is supplied for radio operation, it will be fitted with a TNC coaxial connector as shown

The antenna (aerial) can connect directly to this connector, or can connect to it via a lightning protection unit, which is recommended where the aerial is mounted outside.

Radio regulations are such that – for most applications - it is illegal to transmit greater than 500mW from the aerial.

For this reason, only the aerials specified with the system should be connected.

For more information, refer to the Technical Manual.

### **Leased Line:**

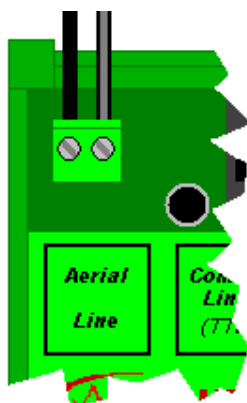

Nano\_Link can be equipped for use on leased telephone lines supplied by national network providers such as BT.

The modems are capable of operating with an end-to-end loss of up to 27dB and provide correct impedance matching in line with the regulations.

Normal telephone wires have a loss of about 1.5dB per km, giving a range of typically 18km.

If more than one outstation is used, the line becomes mismatched. The network provider can normally arrange for matching pads or line amplification to overcome this.

For more information, refer to the Technical Manual.

### **Private Wire:**

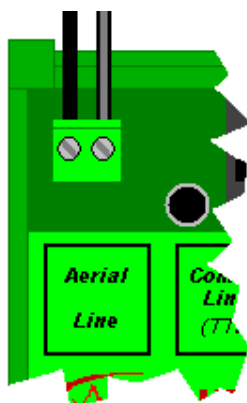

Private wires are cable pairs similar to leased lines, but owned by the user. The user is thus responsible for the maintenance of the cable, but does not have to pay rental charges.

Over short distances the cable characteristics are unimportant. However for distances greater than 2km, the cable should be matched to the impedance of the modems, namely 600 Ohms.

The modems are capable of operating with an end-to-end loss of up to 27dB. Normal telephone wires have a loss of about 1.5dB per km, giving a range of typically 18km. If more than one outstation is used, the line becomes mismatched. A high-impedance version of the modem is available to overcome this.

For more information, refer to the Technical Manual.

## I/O

The basic Nano\_Link can accept 4 digital and 2 analogue inputs. 'Fully-fitted' versions also have 4 digital and 2 analogue outputs. The basic connection requirements are shown below. For more information, refer to the Technical Manual.

Nano\_Link provides a switched 12V supply output, which can be used to power transducers - connections from this are shown in **red**. Alternatively, transducers may be externally powered - these connections are shown in **blue**.

( If the relays are used to switch inductive loads, such as interposing relays, the load must include transient suppression to prevent excessive voltages during switching. If the load is DC, this is most easily achieved by connecting a reverse-biased diode across the load. If AC, a bi-directional suppressor such as transorb or a voltage dependent resistor should be used )

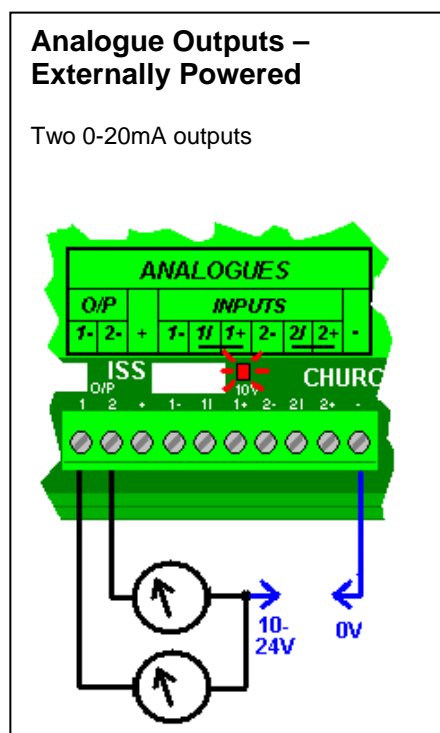
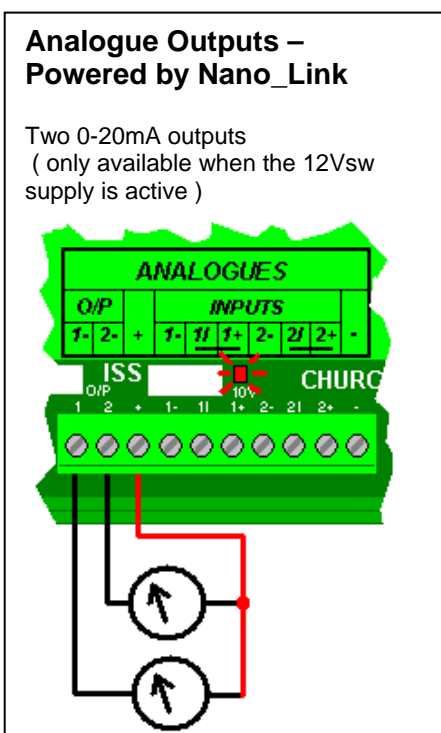
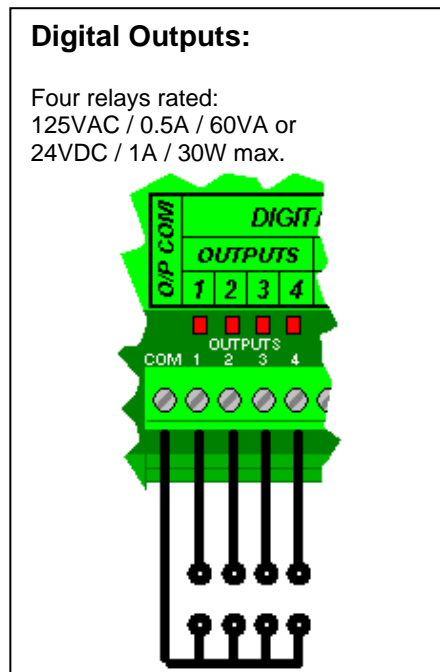
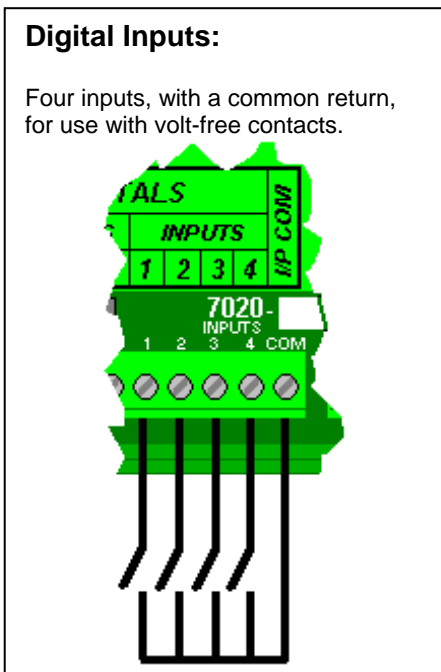

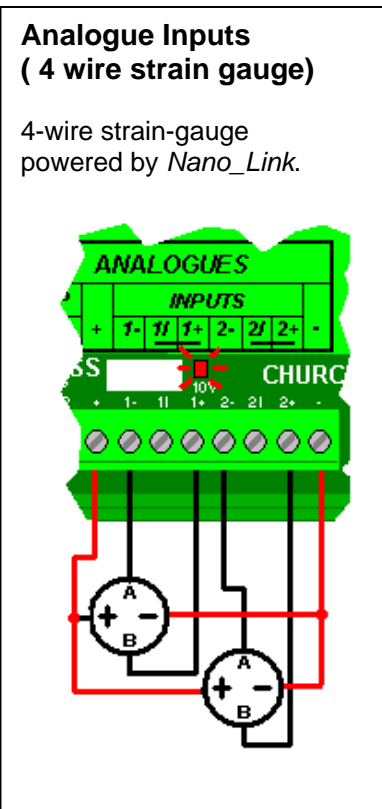
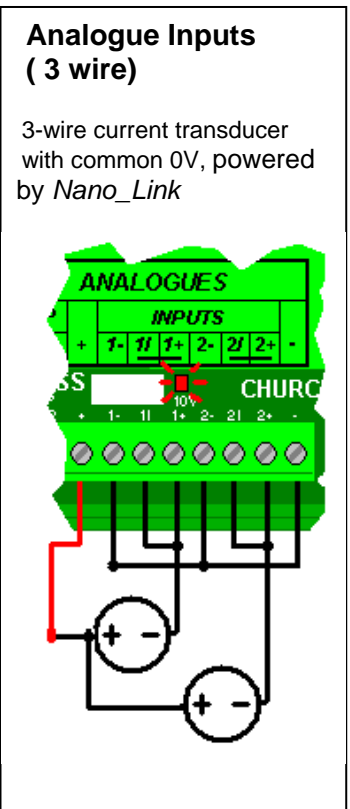
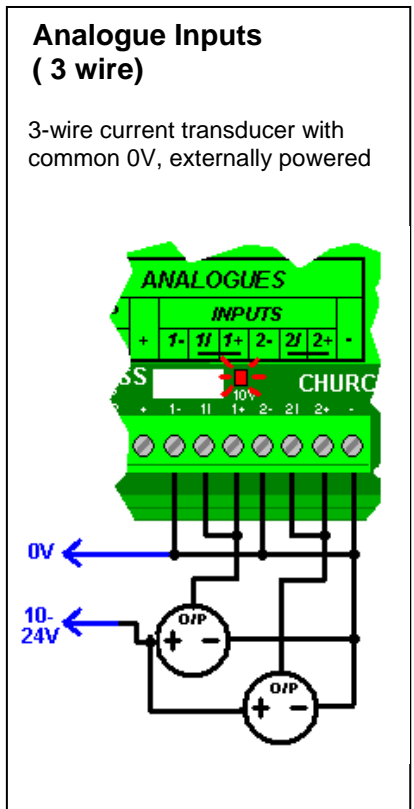
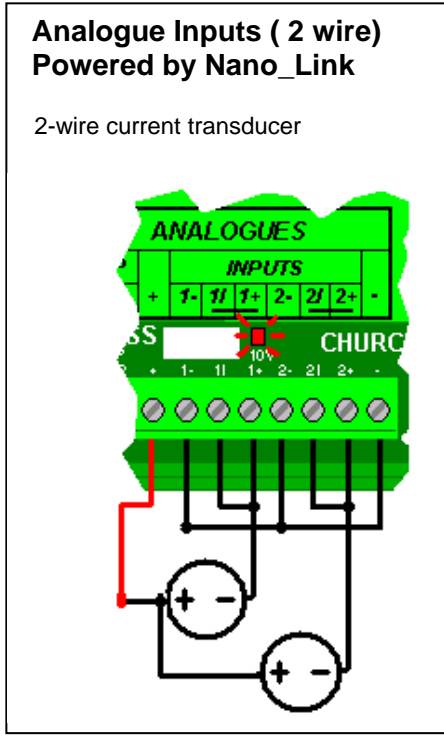
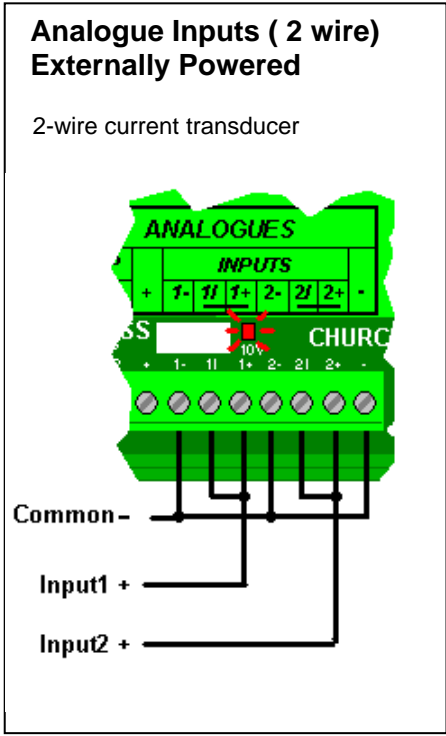

## Configuration

All configurable parameters in Nano\_Link are set using Switch 1 and 2.

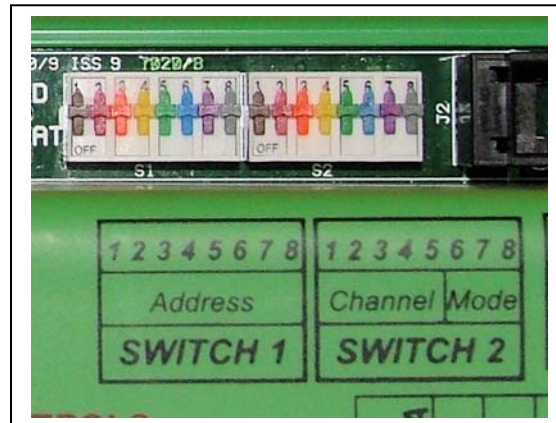

The following illustrations show how these switches must be set for the desired mode of operation.

A switch position of '1' denotes the switch in the 'on' or 'up' position.  
A switch position of '0' denotes the switch in the 'off' or 'down' position.

## Radio Frequency

For a radio link to work correctly, all units must be on the same frequency.  
MPT1329 regulations allow the use of 32 channels within the frequency range 458.5 to 458.925 MHz inclusive.

The radio channel is set using **Switch2, DIP switches 1 to 5.**

Selected switch settings are shown – the full list is in the Technical Manual.

<b>SWITCH 2</b> <b>0 0 0 0</b> Channel 0 458.500 MHz	
<b>SWITCH 2</b> <b>0 0 1 0 0</b> Channel 4 458.550 MHz	
<b>SWITCH 2</b> <b>0 0 0 1 0</b> Channel 8 458.600 MHz	
<b>SWITCH 2</b> <b>0 0 1 1 0</b> Channel 12 458.650 MHz	
<b>SWITCH 2</b> <b>0 0 0 0 1</b> Channel 16 458.700 MHz	
<b>SWITCH 2</b> <b>0 0 1 0 1</b> Channel 20 458.750 MHz	
<b>SWITCH 2</b> <b>0 0 0 1 1</b> Channel 24 458.800 MHz	
<b>SWITCH 2</b> <b>0 1 0 1 1</b> Channel 26 458.850 MHz	

## Unit Address

In order for the radio system to be able to send and receive data between units, each unit must have a unique address.  
Refer to the Technical Manual for more information

The Address is set using **Switch1**.

### Basestation

Basestations are always Address 0.

*A Nano Link Basestation can only interrogate one outstation.*

The default is to interrogate Outstation Address 1, although interrogation of Outstations 2 to 31 can also be configured by setting 6,7 and 8 to ON.

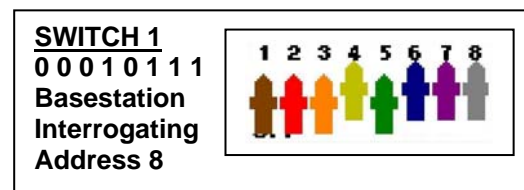
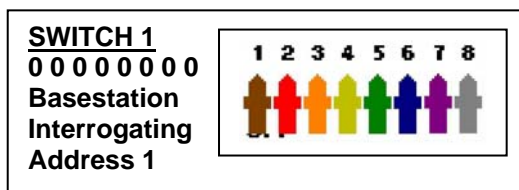

### Outstation

Outstations may have Address 1-223.

If there is more than one Outstation on a system, It is recommended that subsequent Outstations are given Addresses 10, 20, 30 etc. to allow for outstation expansion – which can then occupy the gaps in between.

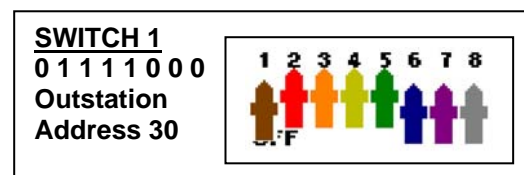
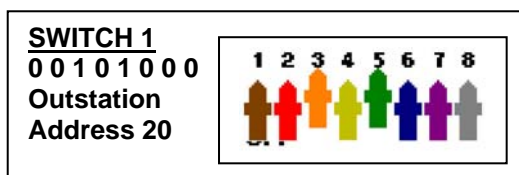
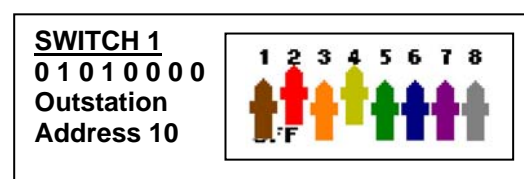
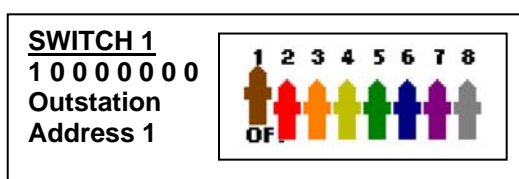

# Operating Modes

**Basestations** have two variants of normal operation. The modes are set using **Switch2, poles 6, 7, and 8**

In **Continuous Transmission mode** the base-station will continuously scan the outstation. This is the recommended mode for leased-line systems, but radio systems should not be left in this mode.

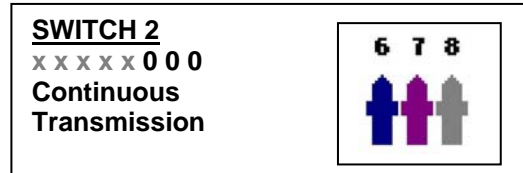

In **Slow Scan mode** the base-station will initially scan every 10 seconds. This slows the system response, but reduces the channel usage. If the outstation reports that it is battery-powered, the base-station automatically converts to scanning it every 15 minutes to conserve the outstation battery.

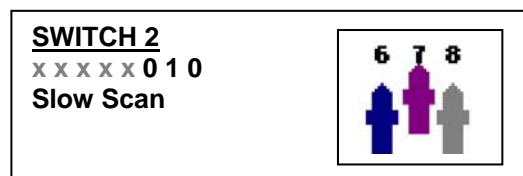

**Outstations** can be set for various power saving options – dependant on whether the unit is battery powered, and also transducer power requirements.

Nano\_Link provides a switched 10V output for powering transducers. To save power when using battery or solar supplies, this supply will only come on just before the analogue reading needs to be taken. The time for which this is present before the analogue input is sampled is the 'settling time'.

The modes are also set using **Switch2, poles 6, 7, and 8.**

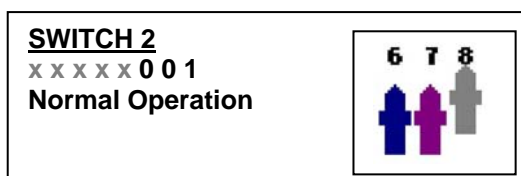
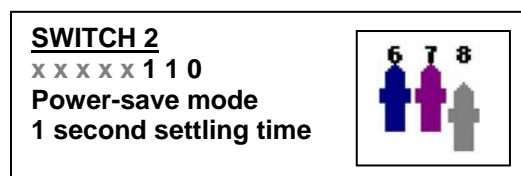
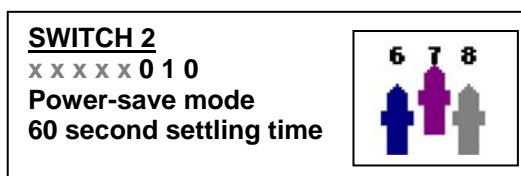
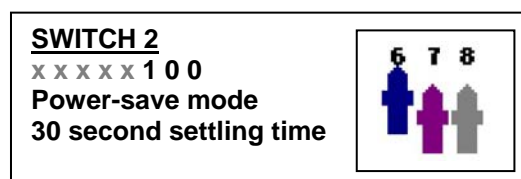
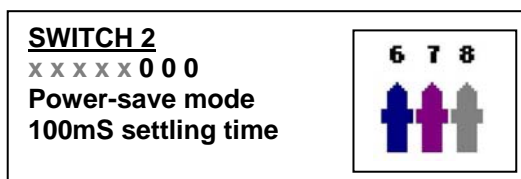

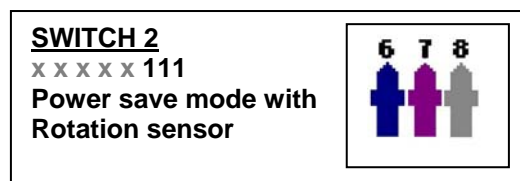
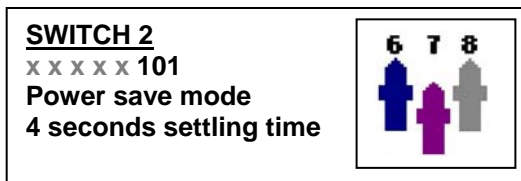

## Operation

### To check the Operation of a point-to-point Nano Link system

At the base station (address zero) check that switch 2 - 7 is off - to enable continuous communications for testing.

You will need to be at the base station (address zero) to check if communication between the sites is satisfactory. It is a good idea to set up known input conditions at the outstation, e.g. close Digital input three and apply a known current to Analogue input 1.

If all is well the heartbeat LED at the basestation will be flashing continually, and the outputs will copy the outstation inputs.

If the *Nano\_Link* is performing as described above you have successfully installed the link.

Connect up the site inputs/outputs as necessary. If using radio and/or a battery powered outstation set Switch 2 pole 7 to ON and return to the outstation to remove the test sensors and complete the wiring of site sensors.



If the heart beat LED is not flashing continually then a fault is indicated. Re-check the settings of the dual in line switches and check antennas or line connections as applicable if you are sure that all is correct please call us on 0118 9892200 for assistance.

## Heartbeat LED Diagnostic Codes

### Continually flashing

Communications and battery supplies normal, Link is operating satisfactorily.

### Three flashes followed by gap:

Communications fail, reported as a priority even if batteries are low.

### Two flashes followed by gap:

Local battery supply low, reported if communications normal even if remote battery is low.

### One flash followed by gap:

Remote battery supply low reported if communications and local battery are normal.

## Alarm Handling

As well as indicating fault conditions on the Heartbeat led, Nano\_Link outstations and basestation can indicate them on digital outputs ( if fitted ). Full details of this feature are given in the Technical Manual.

## Expansion

Nano\_Link includes an 'I/O Link' port which can be used to connect expansion modules from the Data\_Link range.

The expansion capability is limited to one 16-way digital input module and/or one 16-way digital output module. If a digital input module is used it must be set to address 0. If a digital output module is used it must be set to address 1.

Expansion modules cannot be used on battery-powered units.

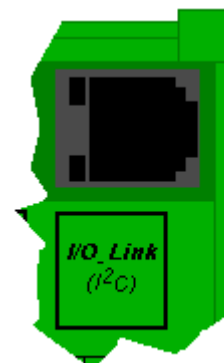

## Exception Reporting

Nano\_Links also support exception reporting. This feature is configured via commands sent to the outstation by a Micro\_Link basestation – hence the feature is not available for Nano\_Link-only systems. Refer to the Technical Manuals for further details.

## Alphanumeric Display Module

The Alphanumeric Display Module comprises an LCD display plus three push buttons. It connects to Nano\_Link via the I/O bus as mentioned above.

The display module can be used as an optional diagnostic tool, but is essential when using shaft encoders.

Full details of its operation are in the Technical Manual.

